

LEDA

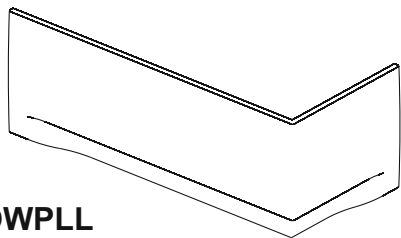

OWPLL
OWPLP

Tablier baignoire rectangulaire
Aprons for rectangular bathtub

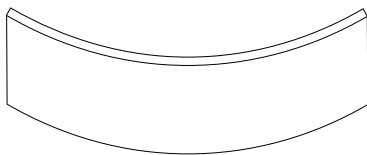

OWS

Tablier baignoire d'angle
Aprons for corner bathtub

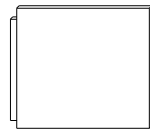
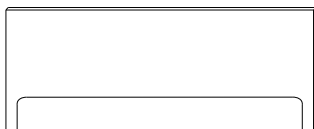

OWP

Tablier baignoire rectangulaire
Aprons for rectangular bathtub

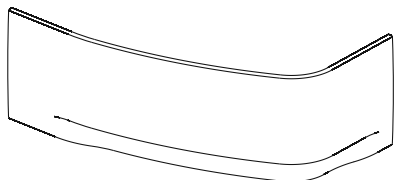

OWAL
OWAP

Tablier baignoire asymétrique
Aprons for asymmetric bathtub

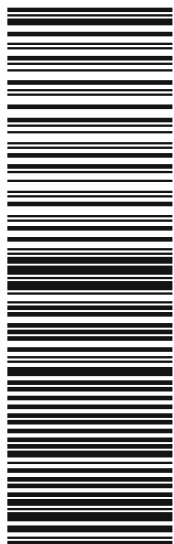

(01)2000001873232(94)AllBlank





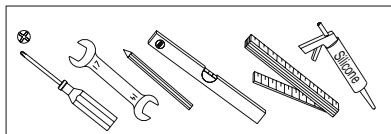

FRISBEE

FR Notice de montage du caisson

GB Installation instruction for aprons

FRISBEE



	wer. a			wer. b		
	①	②	③	④	⑤	⑥
OWP 70, 75, 80 Tablier baignoire rectangulaire Aprons for rectangular bathtub			 M6x12		 4,2x13	
	2	2	2	2	2	2
OWP 120, 130, 140, 150, 160, 170, 180 Tablier baignoire rectangulaire Aprons for rectangular bathtub						
	4	4	4	4	4	4
OWPLL(P) Tablier baignoire rectangulaire Aprons for rectangular bathtub						
	6	6	6	6	6	6
OWS Tablier baignoire d'angle Aprons for corner bathtub						
	5	5	5	5	5	5
OWAL(P) Tablier baignoire asymétrique Aprons for asymmetric bathtub						
	5	5	5	5	5	5

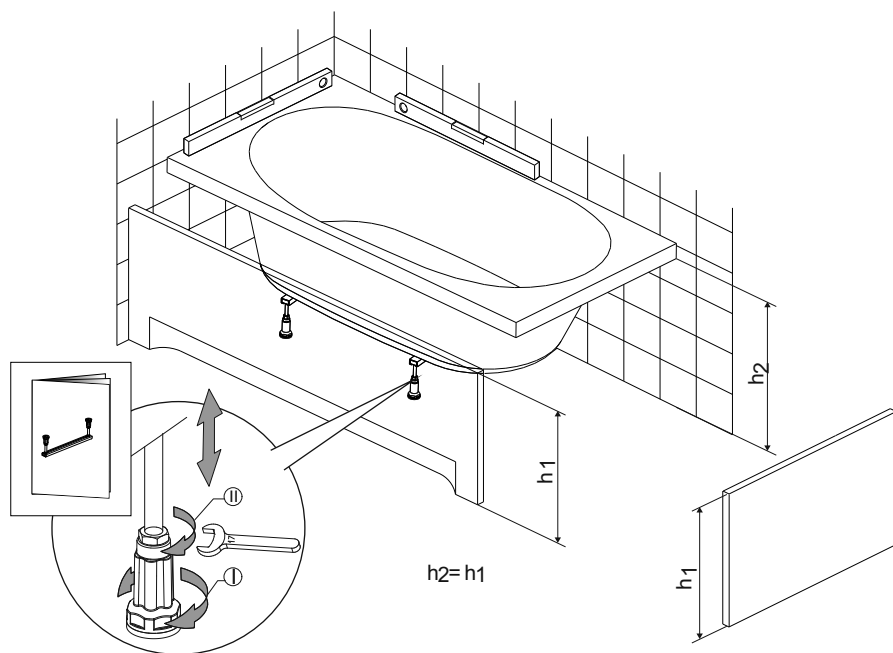

OWP
 Tablier baignoire
 rectangulaire
 Aprons for
 rectangular bathtub

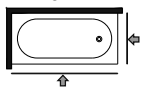

OWPLL(P)
 Tablier baignoire
 rectangulaire
 Aprons for
 rectangular bathtub

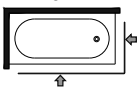

OWP
 Tablier baignoire
 rectangulaire
 Aprons for
 rectangular bathtub

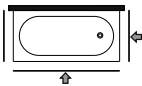

OWAL(P)
 Tablier baignoire
 asymétrique
 Aprons for
 asymmetric bathtub

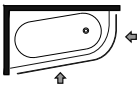

OWP
 Tablier baignoire
 rectangulaire
 Aprons for
 rectangular bathtub

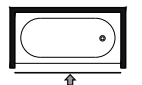

OWS
 Tablier baignoire
 d'angle
 Aprons for
 corner bathtub

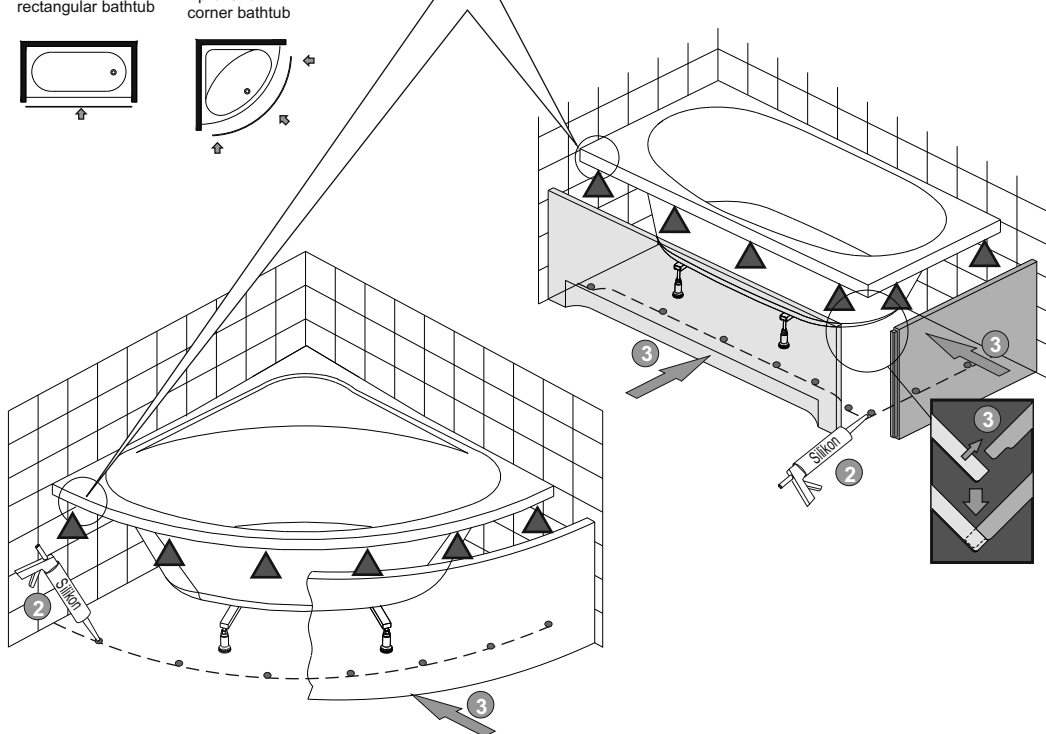
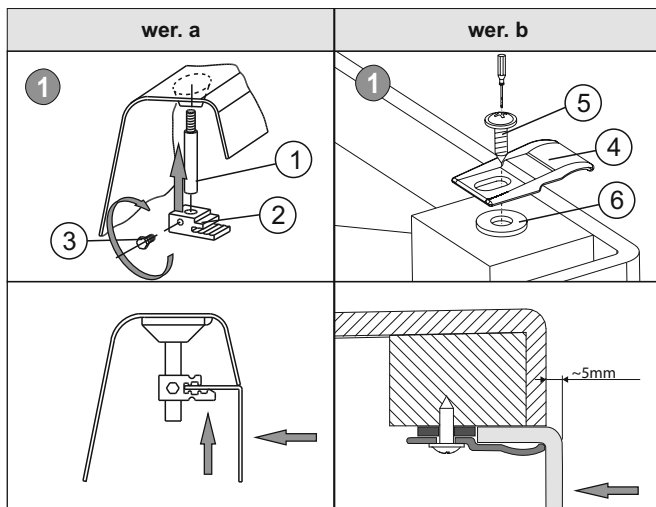
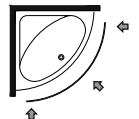

FR MONTAGE : En raison de la nécessité de respecter les paramètres optimaux, le constructeur recommande de confier le montage à un installateur convenablement qualifié. Une liste actuelle des points de service est affichée sur le site d'Internet www.sanplast.pl. **SOINS ET ENTRETIEN :** Nettoyer périodiquement avec un chiffon doux ou une éponge, en n'utilisant que des produits chimiques doux, destinés à nettoyer et à entretenir l'acrylique sanitaire. Ne pas utiliser les produits de nettoyage contenant des particules rayant la surface, p. ex. les poudres abrasives. **PETITES RÉPARATIONS:** Les rayures (inférieures à 0,2 mm) peuvent être éliminées par le ponçage de la surface avec un papier abrasif hydrofuge n° 400, et ensuite avec un papier n° 600 et 800, jusqu'à supprimer les rayures. Ensuite, il faut polir la surface avec une pâte de polissage utilisée pour le polissage de surfaces de vernis de l'automobile, jusqu'à obtenir l'éclat. En cas de matage de la surface de l'acrylique, il est recommandé de polir la surface avec la pâte de polissage précitée, jusqu'à obtenir un effet d'éclat. **Attention :** Le constructeur se réserve le droit d'apporter des modifications des caractéristiques techniques et des coloris des éléments décrits.

GB INSTALLATION: Producer recommends installation by the qualified installer to keep optimal parameters of product. Current list of recommended service points can be found at www.sanplast.pl. **CARE AND MAINTENANCE:** It should be periodically cleaned with soft cloth or sponge using only gentle chemical agent for cleaning and maintenance of sanitary acrylic. Do not use cleaners containing drawing the surface elements, for example: powders. **SMALL REPAIRS:** Scratches (not bigger than 0,2mm) can be removed by polishing the surface with waterproof abrasive paper no 400, then with abrasive paper no 600 and 800, until the scratches are completely removed. The surface then should be polished with an abrasive compound used for car lacquer to restore its shine. In case the acrylic surface looks mat, it is recommended to polish it with an abrasive compound until it looks shiny again. **Notice:** The producer reserves the right to introduce changes of technical parameters and colours of described elements.

LEDA

ZA du bois Gasseau
CS 40252 SAMOREAU

77215 AVON CEDEX France

Tél. : 01 60 71 65 65 - Fax : 01 60 71 66 81 - info@leda.tm.fr